

Air flow meter

For ventilation and air-conditioning

Model A2G-25

WIKA data sheet SP 69.04



for further approvals
see page 4



Applications

- For measuring air flows of radial ventilators
- For measuring air flows in ventilation pipes and ducts in conjunction with the A2G-FM measuring probe
- Measurement of differential pressures

Special features

- With analogue output signal (0 ... 10 V or 4 ... 20 mA) or MODBUS® protocol
- Output signal for air flow and differential pressure in one instrument
- Simple and fast mounting and commissioning
- Maintenance-free
- Maximum operating pressure 20 kPa



Air flow meter, model A2G-25

Description

The model A2G-25 air flow meter is used for measuring air flows of gaseous media in ventilation and air-conditioning applications.

The air flow is measured by determining the differential pressure and multiplying it with the K factor. The K factor depends on the ventilator used or, when using pipe/duct measuring probes, on the size and number of probes and is easy and fast to enter in the menu. The different calculation formulas for the air flow are already programmed in the menu of the A2G-25. By choosing the respective radial ventilator manufacturer, the correct formula is automatically taken into account in the calculation.

Electrical analogue output signals for both measurands (DC 0 ... 10 V or 4 ... 20 mA) or the digital Modbus® versions enable the direct connection to control systems or the building automation system.

The measured differential pressure is also shown on the LC display and transmitted via the analogue or digital output signals. Thus the A2G-25 combines two measurements in one instrument. The LC display and the clear menu navigation enable a time-saving and simple commissioning.

With the A2G-25, air flows up to 200,000 m³/h and differential pressures up to 7,000 Pa can be measured.

Specifications

Air flow meter, model A2G-25		
Measuring element	Piezo measuring cell	
Measuring range		
Analogue output signal (DC 0 ... 10 V/4 ... 20 mA)	<ul style="list-style-type: none"> ■ 0 ... 1,000 Pa ¹⁾ ■ 0 ... 2,000 Pa ■ 0 ... 5,000 Pa ■ 0 ... 7,000 Pa 	
Modbus® version	<ul style="list-style-type: none"> ■ 0 ... 2,500 Pa ■ 0 ... 7,000 Pa 	
Accuracy ²⁾		
Measuring ranges 0 ... 1,000, 0 ... 2,000, 0 ... 2,500 Pa	Pressure < 125 Pa	1 % ±2 Pa
	Pressure > 125 Pa	1 % ±1 Pa
Measuring ranges 0 ... 5,000, 0 ... 7,000 Pa	Pressure < 125 Pa	1.5 % ±2 Pa
	Pressure > 125 Pa	1.5 % ±1 Pa
Units (adjustable in the menu)		
Air flow	<ul style="list-style-type: none"> ■ m³/h ■ m³/s ■ l/s ■ cfm 	
Differential pressure	<ul style="list-style-type: none"> ■ Pa ■ kPa ■ mbar ■ inWC ■ mmWC 	
Process connection	Connecting nozzle (ABS), lower mount, for hoses with inner diameter 4 ... 6 mm	
Supply voltage U_B	AC 24 V or DC 24 V ±10 %	
Electrical connection	Cable gland M16 Cover: PG Screw terminals max. 1.5 mm ²	
Output signal		
Voltage	V _{OUT}	DC 0 ... 10 V
	P _{OUT}	DC 0 ... 10 V
	Minimum load	1 kΩ
Current	V _{OUT}	4 ... 20 mA
	P _{OUT}	4 ... 20 mA
	Minimum load	500 Ω
Modbus®	See page 3	
Current consumption		
DC 0 ... 10 V	< 1.0 W	
4 ... 20 mA	< 1.2 W	
Modbus®	< 1.3 W	
Case	Plastic (ABS) Cover: Polycarbonate (PC)	
Mounting	Wall mounting	
Zero point setting	<ul style="list-style-type: none"> ■ Automatic ³⁾ ■ Manually via push button on the printed circuit board 	
Permissible temperatures		
Medium	<ul style="list-style-type: none"> ■ -20 ... +50 °C [-4 ... +122 °F] ■ -5 ... +50 °C [23 ... 122 °F], with automatic zero point setting 	
Ambient	-40 ... +70 °C [-40 ... +158 °F]	
Ingress protection per IEC/EN 60529	IP54	
Weight	150 g	

1) This measuring range is recommended for measuring air flows in conjunction with the model A2G-FM measuring probe.





2) All data refer to the current measured pressure.

3) The automatic zero point setting aligns the zero point from time to time so that a manual zero point setting is not necessary. During the zero point setting (3 seconds every 10 minutes), the output signal and the display show the last measured value.

Modbus® version

Modbus® communication	
Protocol	Modbus® via serial line
Transfer mode	RTU
Interface	RS-485
Byte format	(11 bits) in RTU mode Coding system: 8 bits binary Bits per byte: <ul style="list-style-type: none">■ 1 start bit■ 8 data bits, lowest-order bit is sent first■ 1 bit for parity■ 1 stop bit
Baud rate	Adjustable in the configuration
Modbus® addresses	1 ... 247 addresses selectable in the configuration menu

Approvals

Logo	Description	Country
	EU declaration of conformity <ul style="list-style-type: none"> ■ EMC directive ■ RoHS directive ■ WEEE directive 	European Union
	EAC (option) <ul style="list-style-type: none"> ■ Import certificate ■ EMC directive 	Eurasian Economic Community
	GOST (option) Metrology, measurement technology	Russia
	KazInMetr (option) Metrology, measurement technology	Kazakhstan
-	MTSCHS (option) Permission for commissioning	Kazakhstan

Certificates (option)

- Measurement report per EN 837
- 2.2 test report per EN 10204
- 3.1 inspection certificate per EN 10204

Approvals and certificates, see website

Electrical connection

Output signal DC 0 ... 10 V

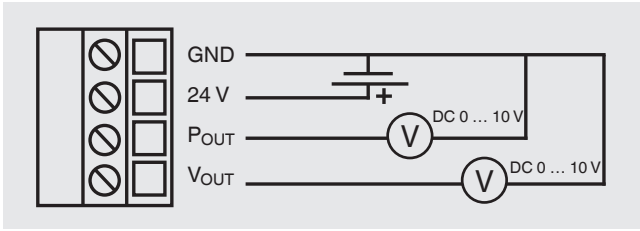

Output signal 4 ... 20 mA

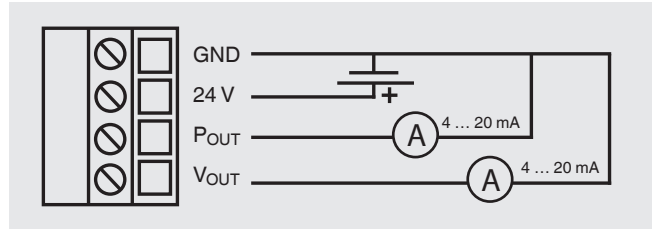

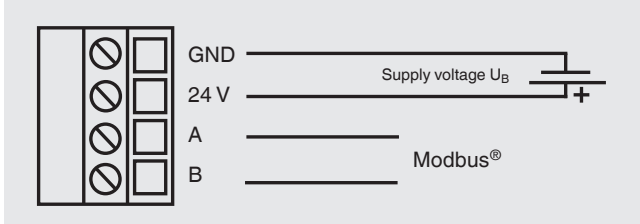

Modbus® output signal

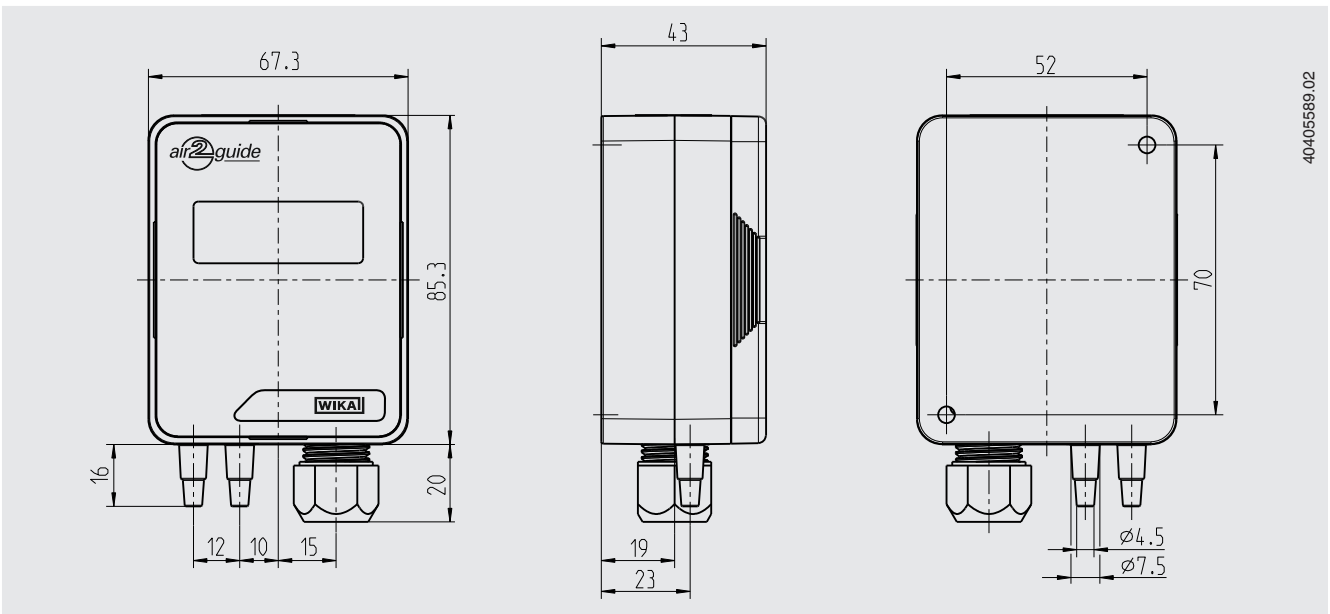

Dimensions in mm



Accessories

Description	Order number
 <p>Measuring hoses</p> <p>PVC hose, inner diameter 4 mm, roll at 25 m</p> <p>PVC hose, inner diameter 6 mm, roll at 25 m</p> <p>Silicone hose, inner diameter 4 mm, roll at 25 m</p> <p>Silicone hose, inner diameter 6 mm, roll at 25 m</p>	<p></p> <p>40217841</p> <p>40217850</p> <p>40208940</p> <p>40208958</p>
 <p>Duct connectors for measuring hoses Ø 4 ... 6 mm</p>	<p>40217507</p>
 <p>Measuring probe for air flow measurement with pitot tube Model A2G-FM, see data sheet SP 69.10</p>	<p>-</p>

Ordering information

Model / Measuring range / Unit / Output signal / Zero point setting / Accessories / Approvals / Certificates / Options

© 03/2009 WIKA Alexander Wiegand SE & Co. KG, all rights reserved.
The specifications given in this document represent the state of engineering at the time of publishing.
We reserve the right to make modifications to the specifications and materials.

